

Dual Sound FM IF Amplifier

TBA 229-2

Bipolar IC

The component contains two separate limiter amplifiers with FM demodulators and separate AF outputs.

Features

- High AM suppression over a very wide input voltage range
- High sensitivity
- Very high symmetry

Type	Ordering Code	Package
TBA 229-2	Q67000-A8037	P-DIP-16

Circuit Description

The component contains two separate FM sound IF sections for television stereo applications or for multistandard receivers. Each FM section consists of an eight-stage symmetrical limiter amplifier followed by a coincidence demodulator and an AF pre-amplifier with a low-ohmic output. The component features considerably improved AM suppression characteristics with small input signals, as well as a very low frequency deviation between THD_{min} and AM_{min} .

Absolute Maximum Ratings

Parameter	Symbol	Limit Values		Unit
		min.	max.	
Supply voltage	V_S	0	16	V
Reference current	I_{REF}	0	2	mA
IF input voltage	$V_{IF\ rms}$	0	600	mV
DC voltages	$V_{9, 10, 11}$	0	V_{REF}	V
	$V_{14, 15, 16}$	0	V_{REF}	V
DC currents	$I_{1, 2, 4, 5, 7, 8}$	0	2	mA
Junction temperature	T_j		150	°C
Storage temperature range	T_{stg}	- 40	125	°C
Thermal resistance (system-air)	$R_{th\ SA}$		80	K/W

Operating Range

Supply voltage	V_S	10.5	15.75	V
Ambient temperature	T_A	0	70	°C
Frequency	f_t	0.1	12	MHz

Characteristics

$V_S = 12\text{ V}$; $T_A = 25\text{ }^\circ\text{C}$; $V_{I\text{F}14\text{ rms}} = 10\text{ mV}$; $f_{I\text{F}11,14} = 5.5\text{ MHz}$; $f_{\text{mod}} = 1\text{ kHz}$; $\Delta f = \pm 30\text{ kHz}$
(if not stated otherwise)

Parameter	Symbol	Limit Values			Unit	Test Condition
		min.	typ.	max.		
Current consumption	I_S	25	35	42	mA	
Input voltage for limiter threshold	$V_{I11\text{ rms}}$		50	100	μV	$V_{Q4,5} = -3\text{ dB}$
	$V_{I14\text{ rms}}$		50	100	μV	
Output voltage	$V_{Q4\text{ rms}}$	510	600	700	mV	
	$V_{Q5\text{ rms}}$	510	600	700	mV	
DC voltage portion	$V_{Q4} =$	4.8	6	6.2	V	$\Delta f = 0$; $THD = THD_{\text{min}}$
	$V_{Q5} =$	4.8	6	6.2	V	
Total harmonic distortion	THD_4, THD_5		0.4	0.8	%	$THD = THD_{\text{min}}$
AM suppression $V_{i\text{ rms}} = 1\text{ mV}$; $m = 30\%$	α_{AM4}	55	60		dB	$V_{i\text{ rms}} = 1\text{ mV}$; $m = 30\%$
	α_{AM5}	55	60		dB	
Cross-talk rejection	$C_{I\text{F}1,2} = V_{Q4}/V_{Q5}$	60			dB	$f_{I\text{F}11} = 5.5\text{ MHz}$; $\Delta f_{11} = 0\text{ kHz}$; $V_{I11\text{ rms}} = 4\text{ mV}$; $V_{I14\text{ rms}} = 10\text{ mV}$ $f_{I\text{F}11} = 5.74\text{ MHz}$; $\Delta f_{14} = 0\text{ kHz}$ $V_{I11\text{ rms}} = 4\text{ mV}$; $V_{I14\text{ rms}} = 10\text{ mV}$
	$C_{I\text{F}1,2} = V_{Q4}/V_{Q5}$	60			dB	
Reference voltage	$V_{13} =$	5.4	6	6.6	V	
Switching voltage muting						
ON (AF off)	V_{16}	8		V_S	V	
OFF	V_{16}	0		3	V	

Design-Related Values

Input resistance	$R_{1,2}$	20			k Ω	
	$R_{17,8}$	20			k Ω	
Output resistance	$R_{Q4,5}$			100	Ω	
Input impedance	$Z_{I11,14}$		800		Ω	
IF residual voltage	$V_{Q4,5\text{ (IF)}}$		15		mV	
Hum suppression	$\alpha_{\text{Q hum}}$		32		dB	$f_S = 100\text{ Hz}$ $\Delta V_{S\text{ rms}} = 500\text{ mV}$; V_S/V_{Q4} ; V_S/V_{Q5}
Frequency deviation $AM_{\text{min}} - THD_{\text{min}}$	$\Delta f_{I\text{F}}$		± 10		kHz	

Block Diagram

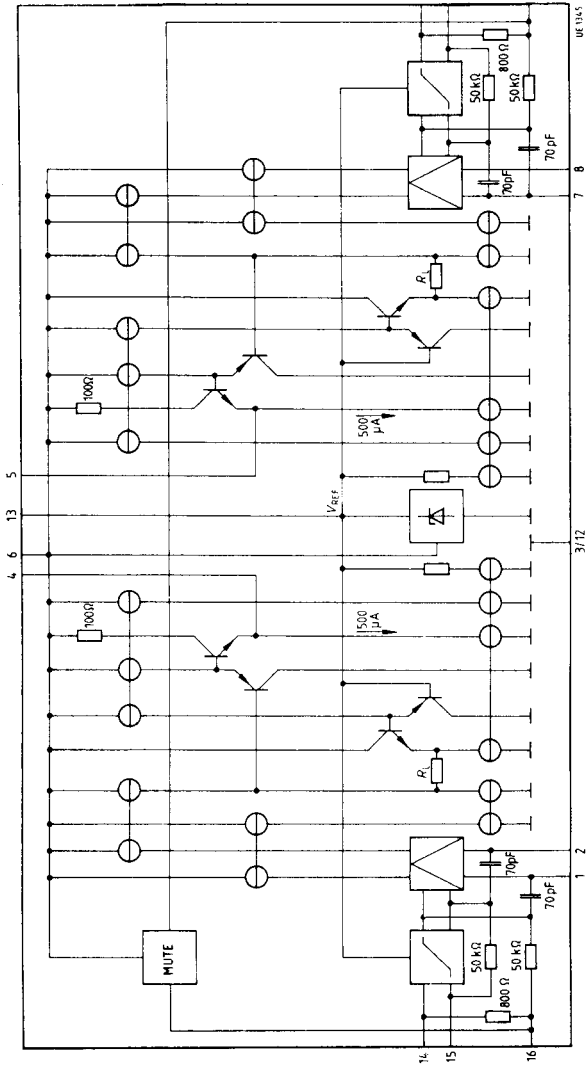

Pin Functions

Pin No.	Function
1, 2	Demodulator tank circuit connection IF 1 (high impedance input – slope of S-curve can be determined by external resistor between pins 1 and 2)
3	GND
4	AF output IF 1 (emitter follower)
5	AF output IF 2 (emitter follower)
6	Supply voltage
7, 8	Demodulator tank circuit connection IF 2 (high impedance input – slope of S-curve can be determined by external resistor between pins 1 and 2)
9	Operating point feedback of limiter amplifier and low end IF 2 (RF decoupling of IF amplifiers with appropriate capacitors is required!)
10	Operating point feedback of limiter amplifier IF 2 (RF decoupling of IF amplifiers with appropriate capacitors is required!)
11	IF 2 input (input of limiter amplifier IF 2; internal resistor between pins 9 and 11 is typ. 800 Ω)
12	GND
13	Internal reference voltage (typ. 6 V)
14	IF 1 input (input of limiter amplifier IF 2; internal resistor between pins 14 and 15 is typ. 800 Ω)
15	Operating feedback of limiter amplifier IF 1 (RF decoupling of IF amplifiers with appropriate capacitors is required!)
16	Operating point feedback of limiter amplifier and low end IF 1 (RF decoupling of IF amplifiers with appropriate capacitors is required!)

Diagrams

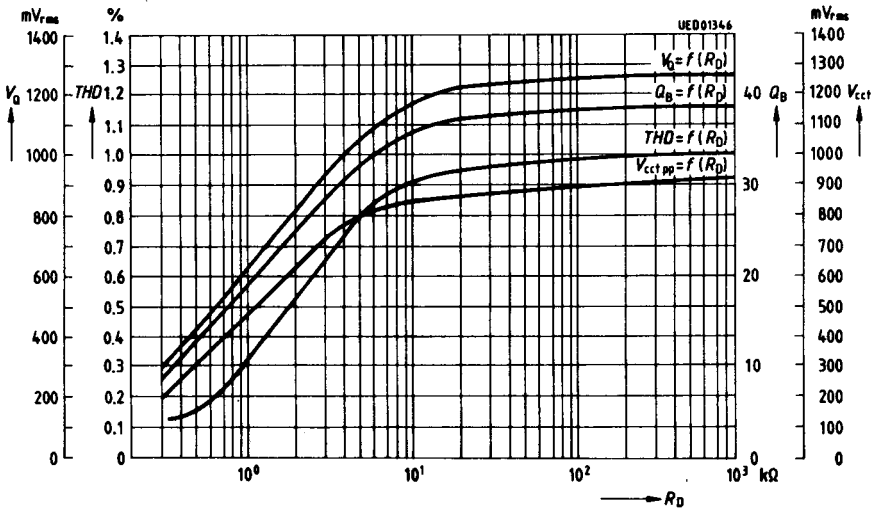
AF Output Voltage, Total Harmonic Distortion,
Circuit Voltage versus Circuit Q_B 

V_O : $V_{O,4 rms}$; $V_{O,5 rms}$

THD : THD_4 ; THD_5

Measured at: $f_{IF} = 5.5 \text{ MHz}$; $\Delta f = 30 \text{ kHz}$; $f_{mod} = 1 \text{ kHz}$; $V_{IF} = 10 \text{ mV}$

V_{Cct} : $V_{1,2} = V_{7,8}$

Measured at: $f_{IF} = 5.5 \text{ MHz}$; $\Delta f = 0 \text{ kHz}$; $V_{IF} = 10 \text{ mV}$

Q_B : Q between connections 1, 2 and 7, 8

Measured at: $f_{IF} = 5.5 \text{ MHz}/\Delta f_{IF}$ for 3 dB bandwidth, $\Delta f = 0 \text{ kHz}$; $V_{IF} = 10 \text{ mV}$

Circuit: $L = 10$ turns 0.25 CuL; Vogt Coil Assembly 517 12 000 00 without cap
 $C = 1 \text{ nF}$ STYROFLEX Capacitor

Tank Voltage versus f_{IF}

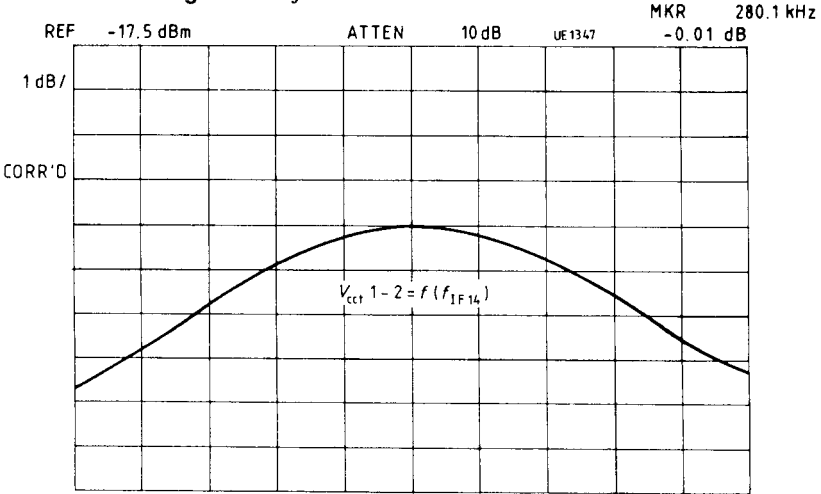

CENTER 5.500 MHz SPAN 320 kHz
 RES BW 3 kHz VBW 10 kHz SWP 100 ms

$$Q_B 1-2 = f_{IF 14} / \Delta f_{14} (-3 \text{ dB}) = 5.5 / 0.28 = 19.64$$

$$V_{cc1 1-2 \text{ max}} = 450 \text{ mV}_{pp}$$

Tank Voltage versus f_{IF}

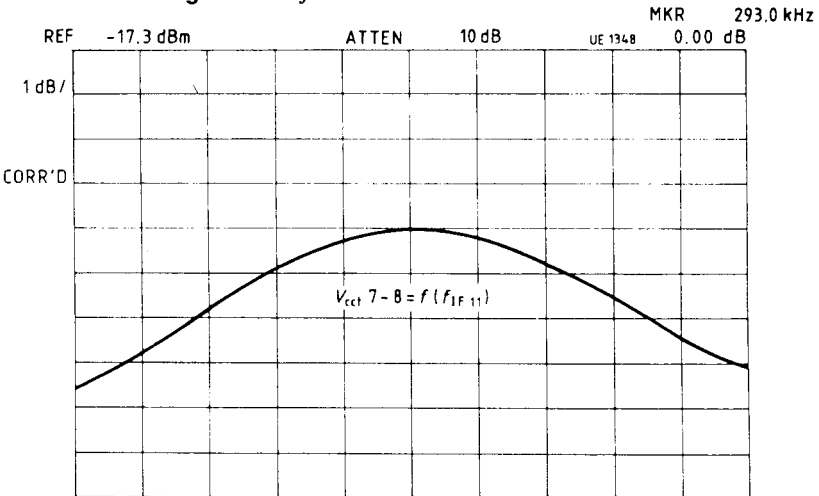

CENTER 5.740 MHz SPAN 320 kHz
 RES BW 3 kHz VBW 10 kHz SWP 100 ms

$$Q_B 7-8 = f_{IF 11} / \Delta f_{11} (-3 \text{ dB}) = 5.74 / 0.293 = 19.59$$

$$V_{cc1 7-8 \text{ max}} = 450 \text{ mV}_{pp}$$

Total Harmonic Distortion versus Detuning (FM Operation)

$THD_4 = f(f_{IF})$; $V_i = 10\text{ mV}$; $V_s = 12\text{ V}$; $f_{mod} = 1\text{ kHz}$,
 $\Delta f = 50\text{ kHz}, 30\text{ kHz}, 12.5\text{ kHz}$

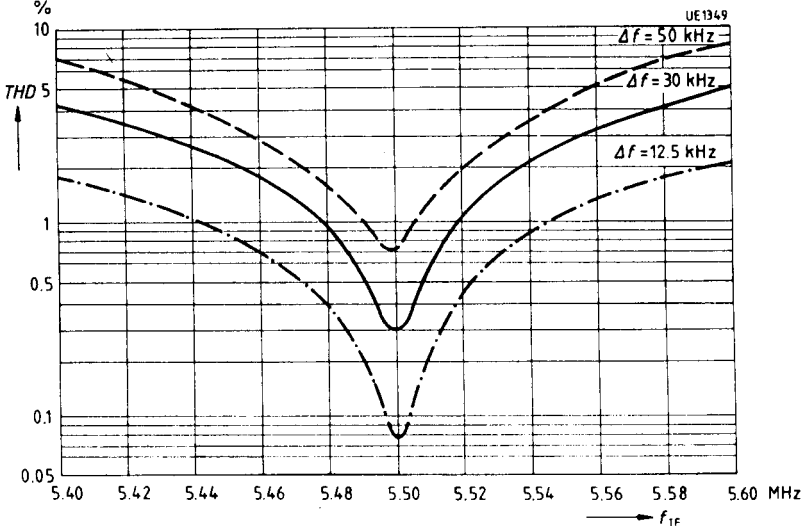

Total Harmonic Distortion versus Detuning (FM Operation)

compensated for minimum total harmonic distortion at $f_{IF} = 5.5\text{ MHz}$;
 $THD = f(f_{IF})$; $V_i = 10\text{ mV}$; $V_s = 12\text{ V}$; $f_{mod} = 1\text{ kHz}$,
 $\Delta f = 50\text{ kHz}; 30\text{ kHz}; 12.5\text{ kHz}$

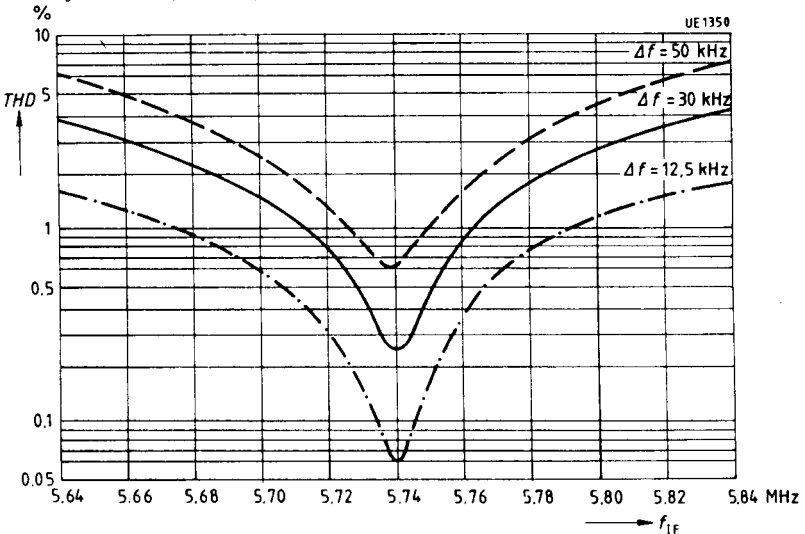

Test Circuit

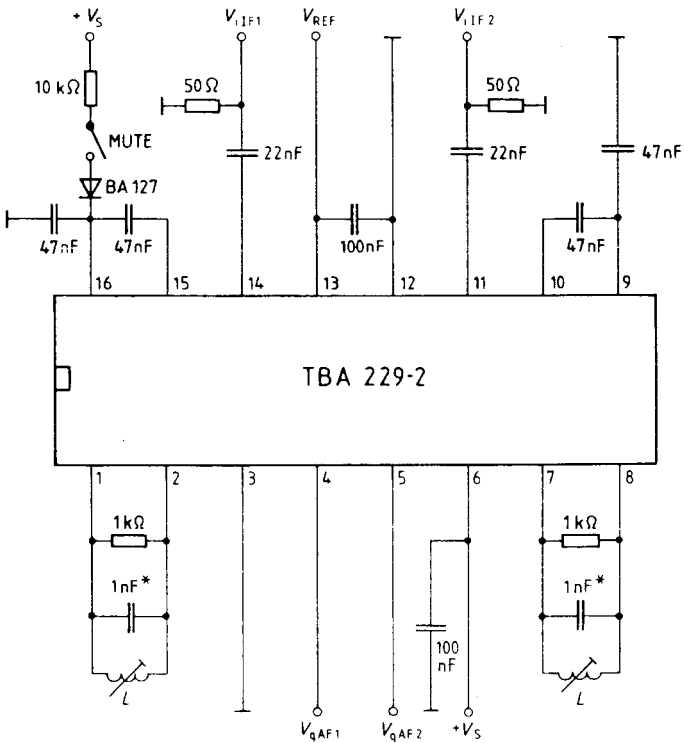

$L = 10 \text{ Turns } 0.2 \text{ CuL}; Q_B \text{ see page "Diagrams"}$
 e.g. Vogt Coil Assembly 517 12 000 00

UE 1351

* STYROFLEX Capacitor

Application Circuit

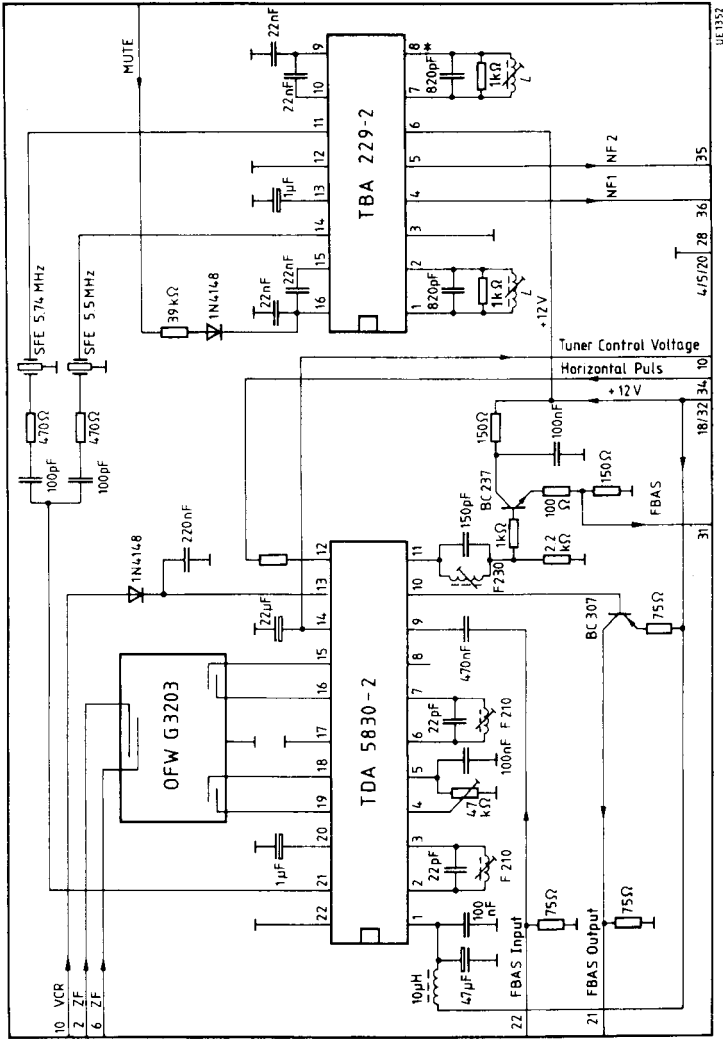

$L = 10$ turns 0.2 CuL; Q_B approx. 25
 e.g. Vogt Coil Assembly 517 12 000 00